

K-No.: 26543

### 1 A Differential Current Sensor for 5V Supply Voltage

For the electronic measurement of current:  
DC, AC, pulsed ..., with galvanic isolation between the primary and the secondary circuit

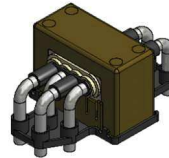

Date: 02.02.2022

Customer: Standard Type

Customers Part no:

Page 1 of 4

#### Description

- Closed loop (compensation) Current Sensor with magnetic probe
- Printed circuit board mounting
- Casing and materials UL-listed

#### Characteristics

- excellent accuracy
- very low offset current
- very low temperature dependency and offset drift
- very low hysteresis of offset current
- short response time
- wide frequency bandwidth
- compact design
- reduced offset ripple

#### Applications

Mainly used for stationary operation in industrial applications:

- Solar inverter

#### Electrical data - Ratings

$I_{PN}$	Primary nominal RMS current	85	A
$I_{\Delta N}$	Differential rated RMS current	1.0	A
$V_{OUT}$	Output voltage @ $I_{\Delta P}$	$V_{REF} \pm (1.2V * I_{\Delta P} / I_{\Delta N})$	V
$V_{OUT(0)}^1$	Output voltage @ $I_{\Delta P}=0A, \theta_A=25^\circ C$	$V_{REF} \pm 0.015$	V
$V_{OUT(Error)}$	in case of error (current sensor) $V_{OUT} < 0.5V$ is set	< 0.5	V
$V_{REF}$	internal reference voltage @ $I_{\Delta P}=0A$	$2.5 \pm 0.005$	V
	external reference voltage range	1.4...3.5	V
$V_{REF(test\ current)}^2$	Reference voltage (external)	0 ... 0.1	V
$V_{OUT(test\ current)}^2$	Output voltage @ $V_{REF} = 0...0.1V$	$V_{OUT(0)} + 0.25 \pm 0.06$	V
$K_N$	Transformation ratio	1:1:1:1 : 20 : 1000	

<sup>1</sup> with switching on and after "test current" the sensor is degaussed by an internal AC-current for about 110ms. In this time the output is set to  $V_{OUT} < 0.5V$ .

<sup>2</sup> If  $V_{REF}$  is set external to 0...0.1V an internal test current is generated.

#### Accuracy – Dynamic performance data

		min.	typ.	max.	Unit
$I_{\Delta P,max}$	Max. measuring range (differential current)	$\pm 1.7$			A
X	Accuracy @ $I_{PN}, \theta_A = 25^\circ C$			1.5	%
$\epsilon_L$	Linearity			1	%
$V_O (V_{OUT}-V_{REF})$	Offset voltage @ $I_{\Delta P} = 0A, \theta_A = 25^\circ C$			15	mV
$\Delta V_O/\Delta T$	Temperature drift of $V_{OUT}$ @ $I_{\Delta P}=0A, \theta_A$		0.05		mV/°C
$t_r$	Response time @ 90% of $I_{\Delta N}$		40		$\mu s$
$f_{BW}$	Frequency bandwidth	DC...8			kHz

#### General data

$\theta_A$	Ambient operation temperature	-40		85	°C
$\theta_S$	Ambient storage temperature (acc to M3101)	-40		85	°C
m	Mass		105		g
$V_C$	Supply voltage	4.75	5	5.25	V
$I_C$	Supply current at $I_{\Delta P} = 0A$ and RT		15		mA

<sup>1, 2</sup> $s_{clear}$  Clearance (component without solder pad)

3.9

mm

<sup>1, 2</sup> $s_{creep}$  Creepage (component without solder pad)

4.5

mm

<sup>1</sup> $U_{sys}$  System Voltage \*determines impulse voltage acc. table 7

600

$V_{RMS}$

<sup>1</sup> $U_{AC}$  Working voltage \*acc. table 10

800

$V_{RMS}$

<sup>1</sup> $U_{PD}$  Rated discharge voltage \*acc. table 24 with  $U_{PD}=U_{AC}*\sqrt{2}$

1132

$V_{PEAK}$

<sup>1</sup>Constructed and manufactured and tested in accordance with IEC 61800-5-1:2007

Prim - Prim: Functional Insolation, Prim - Sec: Basic Insulation,

Insulation material group 1, Pollution degree 2, Overvoltage category III

<sup>2</sup>According to customers specification

Date	Name	Issue	Amendment
02.02.2022	NSch.	82	Applicable documents changed on sheet 3. The color of the plastic material... added. Minor change

Hrg.: R&D-PD NPI D editor

Bearb.: DJ designer

MC-PM: NSch. check

freig.: SB released

K-No.: 26543

## 1 A Differential Current Sensor for 5V Supply Voltage

For the electronic measurement of current:  
DC, AC, pulsed ..., with galvanic isolation between  
the primary and the secondary circuit

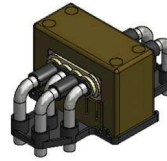

Date: 02.02.2022

Customer: Standard Type

Customers Part no:

Page 2 of 4

### Mechanical outline (mm):

### General tolerances DIN ISO 2768-c

### Connections:

Pin 5-10: 0.7mm x 0.7mm  
Pin 1-4, 11-14: Ø4.5mm

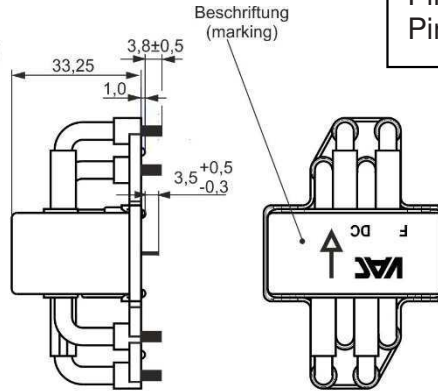
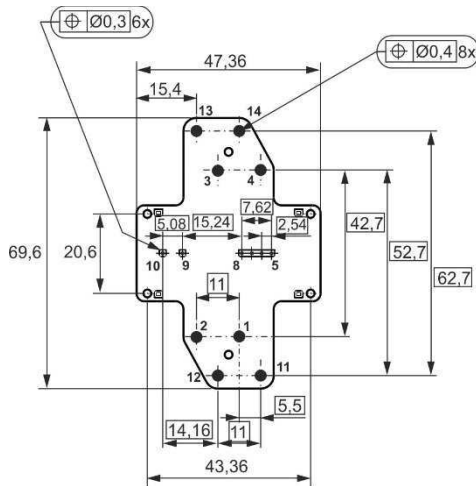

### Marking:

**VAC**  
UL-sign  
4646-X931  
F DC

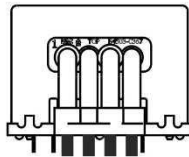

Prüfmaß  
(test dimension)

Ohne Maßstab gezeichnet  
(without scale drawn)

DC = Date Code  
F = Factory

**Current direction: A positive output voltage appears at point  $V_{OUT}$ ,  
if primary current flows in direction of the arrow.**

### Schematic diagram:

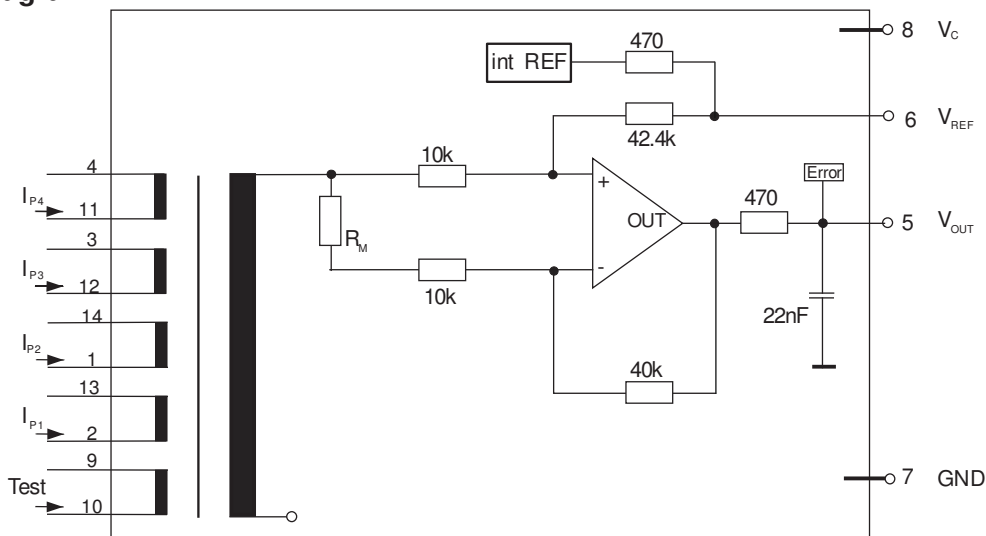

K-No.: 26543

### 1 A Differential Current Sensor for 5V Supply Voltage

For the electronic measurement of current:  
DC, AC, pulsed ..., with galvanic isolation between the primary and the secondary circuit

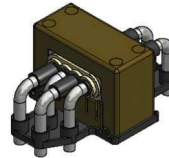

Date: 02.02.2022

Customer: Standard Type

Customers Part no:

Page 3 of 4

#### Electrical data: (investigate by a type checking)

		min.	typ.	max.	Unit
$V_{C,max}$	maximum supply voltage (without function)			6	V
$I_c$	Supply current with primary current	$16mA + I_{\Delta P} \cdot K_N + V_{OUT}/R_L$			mA
$I_{OUT,SC}$	Short circuit output current		$\pm 20$		mA
$R_s$	Secondary coil resistance @ $\theta_A = 85^\circ C$			80	$\Omega$
$R_{Test}$	Test winding resistance @ $\theta_A = 25^\circ C$		0.9		$\Omega$
$R_{P1,P2}$	Primary wire resistance @ $\theta_A = 25^\circ C$		0.1		m $\Omega$
$R_{i,REF}$	Internal resistance of reference input		470		$\Omega$
$R_{i,OUT}$	Output resistance of $V_{OUT}$		470		$\Omega$
$\Delta X_{Ti}/\Delta T$	Temperature drift of X @ $\theta_A = -40^\circ C \dots 85^\circ C$			400	ppm/K
$\Delta V_{REF}/\Delta T$	Temperature drift of $V_{REF}$ @ $\theta_A = -40^\circ C \dots 85^\circ C$		5	50	ppm/K
$\Delta V_{O=}$ $\Delta(V_{OUT}-V_{REF})$	Sum of any offset drift including:		30		mV
$V_{Ot}$	Long term drift of $V_O$		10		mV
$V_{OT}$	Temperature drift of $V_O$ @ $\theta_A = -40^\circ C \dots 85^\circ C$		10		mV
$\Delta V_O/\Delta V_C$	Supply voltage rejection ratio		20		mV/V
$V_{OH}$	Hysteresis of $V_{OUT}$ @ $I_{\Delta P} = 0$ (after an overload of $1000 \times I_{\Delta N}$ )		125	250	mV
$V_{OH, Demag}$	Hysteresis after Degaussing			40	mV
$V_{OSS}$	Offsetripple (without external filter)			150	mV
$V_{OSS}$	Offsetripple (with 20 kHz-Filter, first order)		25		mV
$V_{OSS}$	Offsetripple (with 1.6 kHz-Filter, first order)		10		mV
	Mechanical stress according to M3209/3 Settings: 10-2000Hz, 1min/Octave, 2 hours		2		g

#### Routine Tests: (Measurement after temperature balance of the samples at room temperature, SC=significant characteristic)

$V_{OUT} (SC)$	(100%) M3011/6:	Output voltage vs. reference	1182 ... 1218	mV
$V_O$	(100%) M3226:	Offset voltage ( $V_{OUT}-V_{REF}$ )	15	mV
$U_d$	(100%) M3014:	Test voltage, 1s, Pin 1-4 vs. Pin 5-10, *acc. table 21	2.0	kV <sub>RMS</sub>
$U_{PDE}$	(AQL 1/S4)	Partial discharge voltage (extinction)	1.2	kV <sub>RMS</sub>
$U_{PDE} * 1.875$	M3024:	*acc. table 24 Pin 1-4 vs. Pin 5-10	1.5	kV <sub>RMS</sub>

#### Requalification Tests: (replicated every year, Precondition acc. to M3236)

$\hat{U}_W$	M3064	Impulse test (1.2 $\mu$ s/50 $\mu$ s wave form) Pin 1-4 vs. Pin 5-10	6	kV
$\hat{U}_{W, prim-prim}$	M3064	Impulse test (1.2 $\mu$ s/50 $\mu$ s wave form) Pin 1 vs. Pin 11,12 and Pin 12 vs. Pin 1,2	6	kV
$U_d$	M3014	Test voltage, 5s Pin 1-4 vs. Pin 5-10	2.0	kV <sub>RMS</sub>
$U_{d, prim-prim}$	M3014	Test voltage between primary conductors, 5s Pin 1 vs. Pin 11,12 and Pin 12 vs. Pin 1,2	2.0	kV <sub>RMS</sub>
$U_{PDE}$	M3024	Partial discharge voltage (extinction)	1.2	kV <sub>RMS</sub>
$U_{PDE} * 1.875$		*acc. table 24	1.5	kV <sub>RMS</sub>

\* IEC 61800-5-1:2007

#### Other instructions

- Temperature of the primary conductor should not exceed 100°C.
- Housing and bobbin material UL-listed: Flammability class 94V-0.
- Further standards: UL 508, file E317483, category NMTR2 / NMTR8
- The color of the plastic material is not specified and the current sensor can be supplied in different colors (e.g. brown, black, white, natural). This has no effect on the specifications or UL approval.

Hrg.: R&D-PD NPI D  
editor

Bearb.: DJ  
designer

MC-PM: NSch.  
check

freig.: SB  
released

K-No.: 26543

### 1 A Differential Current Sensor for 5V Supply Voltage

For the electronic measurement of current: DC, AC, pulsed ..., with galvanic isolation between the primary and the secondary circuit

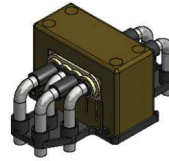

Date: 02.02.2022

Customer: Standard Type

Customers Part no:

Page 4 of 4

#### Explanation of several terms used in the tables:

$V_{Ot}$  Long term drift of  $V_O$  after 100 temperature cycles in the range  $-40^{\circ}\text{C}$  to  $85^{\circ}\text{C}$ .

$t_r$  Response time, measured as a delay time at  $I_{\Delta P} = 0.9 \cdot I_{\Delta N}$  between a rectangular primary current and the output current or voltage.

$t_{ra}$  Reaction time, measured as a delay time at  $I_{\Delta P} = 0.1 \cdot I_{\Delta N}$  between a rectangular primary current and the output current or voltage.

$X_{ges}(I_{\Delta N})$  The sum of all possible errors over the temperature range by measuring a current  $I_{\Delta N}$ :

$$X_{ges}(I_{\Delta N}) = 100 \cdot \left| \frac{V_{OUT}(I_{\Delta N}) - 2.5V}{1.2V} - 1 \right| \%$$

$X$  Permissible measurement error in the final inspection at RT, defined by

$$X = 100 \cdot \left| \frac{V_{OUT}(I_{\Delta N}) - V_{OUT}(0)}{1.2V} - 1 \right| \%$$

$\epsilon_L$  Linearity fault defined by:  $\epsilon_L = 100 \cdot \left| \frac{I_{\Delta P}}{I_{\Delta N}} - \frac{V_{OUT}(I_{\Delta P}) - V_{OUT}(0)}{V_{OUT}(I_{\Delta N}) - V_{OUT}(0)} \right| \%$

Where  $I_P$  is any input DC current and  $V_{OUT}$  the corresponding output term. ( $I_0 = 0$ ).

RT Room temperature

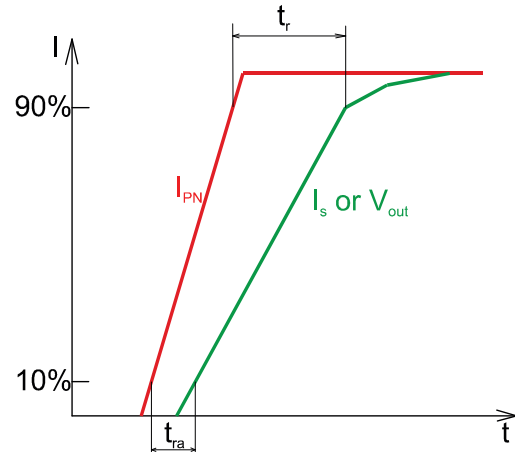

#### Application Information

The external test current can be generated with the use of a resistor  $R$  and a switch  $X$  or something similar (Transistor, Mosfet, etc.). The resistor determine the current at a given voltage and so the output voltage can be calculated.

$$V_{OUT} = V_{REF} \pm \frac{1.2 \cdot \frac{5V}{R + R_{Test}} \cdot 20}{I_{\Delta N}}$$

